

# PROFILSYSTEME FASSADENSYSTEME

Präsentationssysteme

Display

Pylonen

# FRAMELESS-HOLZ

# FRAMELESS

Frameless-Outlip/Outled

# TEXTIL - PLANENWARE

LED Systeme

Verkehrsspiegel

Wechselrahmen

Schildersysteme

Stadtmöblierungen

Schaukästen – Vitrinen



Gertrude Melenka 1802

pro4sign, frame4sign & tex4sign

PREISLISTE / MMXIX-I

HP&V-Partner  
Gertrude Melenka  
Rettenbachstrasse 162  
5730 Mittersill  
T: +43 6562 8573  
F: +43 6562 8573 34  
[www.hpv-partner.com](http://www.hpv-partner.com)  
[office@hpv-partner.com](mailto:office@hpv-partner.com)



## Inhalt

pro4sign	EPS.LUMI - Profile	Seite 3
pro4sign	EPS.LUMI - Werkzeug	Seite 4
pro4sign	EPS.LUMI - Elemente	Seite 4
pro4sign	EPS.REDY - Profile	Seite 5
pro4sign	EPS.REDY - Komponenten	Seite 6
pro4sign	EPS.EASY - Profile	Seite 7
pro4sign	EPS.EASY - Befestigungen	Seite 8
tex4sign	TEXTIL - Planenware	Seite 9/10
frame4sign	wood edition - rahmenlose Spanntechnik	Seite 11
frame4sign	SlimFrame & SlimLight rahmenlose Spanntechnik	Seite 12
frame4sign	SlimFrame – Zubehör	Seite 13
frame4sign	SlimFrame - Zubehörliste	Seite 14
	allg. Geschäftsbedingungen	Seite 15

## Zahlungs- und Lieferbedingungen

### Frachtkostenpauschalangebot ab Lager:

44,50 Frachtkosten für Profillängen bis 3,5m

89,00 Frachtkosten für Profillängen ab 3,5m

89,00 Frachtkostenpauschale für 1 Standardrolle bis 3,2m

175,00 Frachtkostenpauschale für 2 - 6 Standardrollen bis 3,2m

205,00 Frachtkostenpauschale für 1 - 6 Standardrollen ab 4,2/5,0m

**Ab € 5000,- Warenwert (Standardrollen), frei Haus**

Zwischenverkauf vorbehalten

Preise exkl. 1,95% Verpackungs- und Handlingskosten vom Warenwert

Lieferart: ab Werk, zzgl. Mwst. - Staplerentladung kundenseits

Selbstabholung: nur gegen Rücksprache

Irrtümer vorbehalten

**\* nicht lagernde Ware – Frachtkosten auf Anfrage**

## Firmensitz

Zentrale:

HP&V-Partner

Gertrude Melenka

5730 Mittersill, Rettenbachstrasse 162

T: +43 6562 8573

F: +43 6562 8573 34

M: [office@hvp-partner.com](mailto:office@hvp-partner.com)

W: [www.hvp-partner.com](http://www.hvp-partner.com)

Lager:

Sped. Schweiger GmbH

Reichenhaller Str. 87

83435 Bad Reichenhall/BRD



















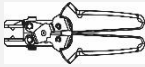



<b>EPS. LUMI</b>				<b>Profile</b>
<b>Artikel</b>	<b>Abbildung</b>	<b>Profilmaß</b>	<b>Anzahl/VE</b>	<b>Preis/lfm</b>
EPS 1-001 Grundprofil breit		240x6000mm	6	<b>33,20</b>
EPS 1-004 Grundprofil schmal		170x6000mm	6	<b>22,00</b>
EPS 1-009 * Grundprofil doppelseitig		260x6000mm	-	<b>47,10</b>
EPS 1-011 * Aufsatzprofil 83 JR		83x6000mm	-	<b>16,20</b>
EPS 1-015 Aufsatzprofil JR leicht		85x6000mm	6	<b>12,40</b>
EPS 1-016 Aufsatzprofil SR schwer		112x6000mm	6	<b>28,10</b>
EPS 1-022 Abdeckprofil JR leicht		57x6000mm	6	<b>4,10</b>
EPS 1-023 Abdeckprofil SR schwer		63x6000mm	6	<b>4,90</b>
EPS 1-021 * Abdeckprofil JR Wassernase		60x6000mm	-	<b>4,80</b>

<b>EPS. LUMI GRIP</b>				<b>Profile</b>
<b>Artikel</b>	<b>Abbildung</b>	<b>Profilmaß</b>	<b>Anzahl/VE</b>	<b>Preis/lfm</b>
EPS 1-101 Grund- inkl. Abdeckprofil		176x6000mm	6	<b>24,40</b>
EPS 1-111 Aufsatz- inkl. Abdeckprofil		67x6000mm	6	<b>13,90</b>
EPS 1-121 Wand- inkl. Abdeckprofil		50x6000mm	6	<b>19,90</b>

<b>EPS. LUMI GRIP</b>				<b>Elemente</b>
<b>Artikel</b>	<b>Abbildung</b>	<b>Profilmaß</b>	<b>Anzahl/VE</b>	<b>Preis/Stk</b>
EPS 1-086 Verbindungsplatte		92x150mm für EPS 1-101	1	<b>3,75</b>
EPS 1-087 Eckverbinder		50x50x92mm für EPS 1-101	1	<b>2,90</b>







\* kein Lagerartikel – auf Anfrage







EPS. LUMI			Werkzeuge		
Artikel	Abbildung		Anzahl/VE	Preis	
EPS 1-058 Druckluft-Meisel			1	34,-	
EPS 1-060 Gummihammer			1	11,-	
EPS 1-062 Tuchhalter-Spanner			1	19,-	
EPS 1-063 Profillöser			1	4,-	
EPS 1-064 Tuchhalter-Hebel			1	39,-	
EPS 1-065 Tuchhalter-Zange			1	20,-	
EPS 1-066 Tuchhalter Zange		High professional	1	178,-	
EPS. LUMI			Elemente		
EPS 1-028 Eckwinkel		66x43x6000mm	4	21,50/lfm	
EPS 1-029 Außenecken-Abdeckung		36x6000mm	4	7,15/lfm	
EPS 1-030 Stoß-Abdeckung		36x6000mm	4	6,10/lfm	
EPS 1-031 Innenecken-Abdeckung		36x6000mm	4	6,90/lfm	
EPS 1-072 Tuchhalter		50mm	500	0,82/Stk	
EPS 1-074 Tuchhalter		50mm	250	0,82/Stk	
EPS 1-077 Tuchhalter		50mm	100	0,82/Stk	
EPS 1-097 Tuchhalter kurz		25mm	100	0,69/Stk	
EPS 1-053 Aussteifungsprofil		für EPS 1-001, 1-004, 1-101	1	3,70/Stk	
EPS 1-042 Verbindungsplatte		für EPS 1-001	1	3,75/Stk	
EPS 1-046 Eckverbinder		für EPS 1-001	1	3,20/Stk	
EPS 1-080 Verbindungsplatte		für EPS 1-004	1	3,75/Stk	
EPS 1-081 Eckverbinder		für EPS 1-004	1	2,90/Stk	







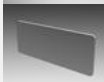

EPS. REDY				Profile
Artikel	Abbildung	Profilmaß	Anzahl/VE	Preis/lfm
EPS 6-002 Profil C		20x9x3500mm	12	<b>4,80</b>
EPS 6-007 Profil KTA+		27x9x3500mm	12	<b>5,80</b>
EPS 6-008 Profil KL+		49x20x3500mm	12	<b>9,40</b>
EPS 6-055 Profil KTN+		37x22x3500mm	12	<b>8,80</b>
EPS 6-045 Profil KT+		64x37x3500mm 64x37x6000mm	4	<b>19,20</b>
EPS 6-047 Profil KT4		37x37x3500mm 37x37x6000mm	4	<b>14,50</b>
EPS 6-057 Profil KT8		86x86x4000mm 86x86x6000mm	4	<b>26,60</b>

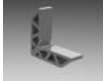
EPS. REDY		Klemmleisten (UV-stabilisiert)		
Artikel	Abbildung	Profilmaß	Anzahl/VE	Preis/lfm
EPS 6-120 (6-100) Klemmleiste <b>CN</b> weiß		3500mm In- & Outdoor	12	<b>1,30</b>
EPS 6-121 (6-108) Klemmleiste <b>CN</b> silber		3500mm In- & Outdoor	12	<b>1,50</b>
EPS 6-122 (6-109) Klemmleiste <b>CN</b> schwarz		3500mm In- & Outdoor	12	<b>1,50</b>
EPS 6-125 (6-110) Klemmleiste <b>CS</b> weiß		3500mm - verstärkt In- & Outdoor	12	<b>1,85</b>
EPS 6-126 (6-112) Klemmleiste <b>CS</b> silber		3500mm - verstärkt In- & Outdoor	12	<b>2,15</b>
EPS 6-127 (6-111) Klemmleiste <b>CS</b> schwarz		3500mm - verstärkt In- & Outdoor	12	<b>2,15</b>



<b>EPS. REDY</b>		<b>Komponenten - KT8</b>		
<b>Artikel</b>	<b>Abbildung</b>	<b>Bezeichnung</b>	<b>Anzahl/VE</b>	<b>Preis/Stk</b>
EPS 6-280 Eckverbinder		EQ KT8L Eckverbinder 90°	1	<b>4,90</b>
EPS 6-282 Eckverstärkung		EQ KT8A Eckwinkel 81x81mm	1	<b>11,50</b>
EPS 6-284 verstellbare Eckverstärkung		EQ KT8F Eckwinkel 40-180°	1	<b>13,50</b>
EPS 6-286 Verbindungsplatte		PL KT8 Verbindungsplatte	1	<b>3,90</b>
EPS 6-271 Nutenstein		CLM M6 T-Nutenstein	35	<b>1,20</b>



<b>EPS. REDY</b>		<b>Komponenten - KT4, KT+</b>		
<b>Artikel</b>	<b>Abbildung</b>	<b>Bezeichnung</b>	<b>Anzahl/VE</b>	<b>Preis/Stk</b>
EPS 6-214 Eckverbinder		EQ ABS Eckverbinder	50	<b>0,64</b>
EPS 6-228 Eckverstärkung 90°		EQ KT+ Eckverstärkung 90°	10	<b>1,50</b>
EPS 6-220 Eck- Wandbefestigung		EQ KT+ MUR Eck- Wandbefestigung	10	<b>3,50</b>
EPS 6-226 verstellbare Eckverstärkung		EQ ART KT+ 0-180°	10	<b>4,90</b>
EPS 6-156 Verbindungsrohr		Aluverbindungsrohr 100mm	10	<b>0,68</b>
EPS 6-271 Nutenstein		CLM M6 T-Nutenstein	35	<b>1,20</b>

<b>EPS. REDY</b>		<b>Komponenten - KL+, KTN+</b>		
<b>Artikel</b>	<b>Abbildung</b>	<b>Bezeichnung</b>	<b>Anzahl/VE</b>	<b>Preis/Stk</b>
EPS 6-214 Eckverbinder		EQ ABS Eckverbinder	50	<b>0,64</b>
EPS 6-241 Befestigungswinkel		PFIX für Rahmenaufhängung	10	<b>2,90</b>
EPS 6-156 Verbindungsrohr		Aluverbindungsrohr 100mm	10	<b>0,68</b>

<b>EPS. REDY</b>		<b>Werkzeug</b>		
EPS 6-300 Gehrungsschere		-	1	<b>55,90</b>



EPS. EASY				Profile
Artikel	Abbildung	Profilmaß	Anzahl/VE	Preis/lfm
EPS 7-001 Kederprofil oval eloxiert		16x40 x 6000mm	6	<b>7,60</b>
EPS 7-001-300 Kederprofil oval eloxiert		16x40 x 3000mm	6	<b>7,80</b>
EPS 7-002 Kederprofil oval natur		16x40 x 6000mm	6	<b>5,90</b>
EPS 7-002-300 Kederprofil oval natur		16x40 x 3000mm	6	<b>6,10</b>
EPS 7-005 Kederprofil rund eloxiert		30 x 6000mm	6	<b>9,30</b>
EPS 7-005-300 Kederprofil rund eloxiert		30 x 3000mm	6	<b>9,50</b>
EPS 7-006 Kederprofil rund natur		30 x 6000mm	6	<b>7,20</b>
EPS 7-006-300 Kederprofil rund natur		30 x 3000mm	6	<b>7,40</b>
EPS 7-010 Alu-Rundrohrkeder		8 x 6000mm	6	<b>2,30</b>

EPS. EASY		Kunststoff - Endstopfen		
Artikel	Abbildung	Profilmaß	Anzahl/VE	Preis/Stk
EPS 7-050 Endstopfen oval		16x40mm	4	<b>0,77</b>
EPS 7-052 Endstopfen rund		D=30mm	4	<b>0,70</b>

EPS. EASY		Verbinder		
Artikel	Abbildung	Beschreibung	Anzahl/VE	Preis/Stk
EPS 7-060 Profilverbinder verzinkt		starr	1	<b>7,91</b>
EPS 7-062 Gelenkverbinder verzinkt		vertikal	1	<b>19,91</b>
EPS 7-064 Gelenkverbinder verzinkt		horizontal	1	<b>19,91</b>



EPS. EASY		Befestigungen		
Artikel	Abbildung	Profilmaß	Anzahl/VE	Preis/Stk
EPS 7-080 EASYQUICK - Wandhalter		96x50mm	1	<b>23,27</b>
EPS 7-086 Einfach - Wandhalter		40mm	2	<b>5,45</b>
EPS 7-088 Boden- / Deckenhalter		40mm	2	<b>4,55</b>
EPS 7-090 Wandflansch		59x50mm	1	<b>25,46</b>
EPS 7-092 Drahtseilspanner		40x15mm	2	<b>9,96</b>
EPS 7-094 Ösenschraube		M5	2	<b>3,95</b>
EPS 7-096 Alu Nutenstein		8mm	2	<b>2,45</b>
EPS 7-098 Boden- / Deckenspanner		35x16mm	2	<b>9,09</b>
EPS 7-100 Boden- / Deckenspanner mit 3-Loch Fußplatte		35x40mm	2	<b>13,05</b>
EPS 7-102 Boden- / Deckenhaken		4,4x83mm	2	<b>1,82</b>
EPS 7-104 Drahtseilspanner/Öse		38x17mm mit Öse	2	<b>8,73</b>
EPS 7-106 Drahtseilspanner/Haken		38x15mm mit Haken	2	<b>8,73</b>
EPS 7-108 Drahtseilspanner/Gew.		0,55kg mit Gewicht	1	<b>18,18</b>
EPS 7-110 Spannschloss		35mm Spannweg mit beidseitiger Ösen	2	<b>3,64</b>
EPS 7-120 Edelstahl - Drahtseil		1,5mmx25m	1	<b>41,82</b>
EPS 7-128 Edelstahl - Drahtseil		1,5mmx10m	1	<b>18,73</b>
EPS 7-134 Alupressklemmen		-	50	<b>0,40</b>





<b>seemee</b> <i>flexface - PVC beschichtet</i>		<b>BACKLIT – SKF, UV, SO, LA</b>			
Artikel	Bezeichnung	Gewicht (g/m <sup>2</sup> )	Breite (cm)	Länge (m)	Preis/m <sup>2</sup>

B 1150	seemee II Backlit <b>B1</b> 5 Jahre Garantie*	550	320	50	<b>8,30</b>
B 3852	seemee IV Backlit <b>B1/M2/UL</b> 7 Jahre Garantie*	550	500/320	50	<b>10,25</b>

B 1149	seemee IV Backlit <b>B1/M2/UL</b> 7 Jahre Garantie*	650	320 /250 168/137	50	<b>10,25</b>
--------	---	-----	---------------------	----	--------------

Die oben angeführten Materialien sind für Druck – UV, Solvent, Latex - und **selbstklebenden namhaften Folien** geeignet.  
\* Jahresqualität lt. Herstellerangabe

<b>seemee</b> <i>flexface – PVC beschichtet</i>		<b>BACKLIT – UV, SO, LA</b>			
Artikel	Bezeichnung	Gewicht (g/m <sup>2</sup> )	Breite (cm)	Länge (m)	Preis/m <sup>2</sup>

B 7727	seemee FR Backlit <b>B1/M2</b>	550	500/320 250/160	50	<b>6,20</b>
B 7970	seemee supreme Backlit <b>B1/M1</b>	450	500/320 250/160	50	<b>4,60</b>

B 7955/56	seemee LED Backlit <b>B1</b> > 40% Transluzenz	320	500/320 250/160	50	<b>5,10</b>
-----------	--	-----	--------------------	----	-------------

<b>seemee</b> <i>3P Textil</i>		<b>BACKLIT – DS, TS, UV</b>			
Artikel	Bezeichnung	Gewicht (g/m <sup>2</sup> )	Breite (cm)	Länge (m)	Preis/m <sup>2</sup>

B 4124	Value Backlit <b>B1</b> <b>nur DS, TS, LA</b>	185	155 250/310	50	<b>3,60</b>
B 4400	Value premium Backlit <b>B1</b>	265	310 250/155	50	<b>5,85</b>
B 4405	seemee studio <b>nur UV, LA</b>	110	320/160	50	<b>3,85</b>

Teilung der Warenbreite: € 0,15/m<sup>2</sup> pro Schnitt – nur bei Abnahme der kompletten Originalbreite

SKF = selbstklebende namhafte Folien  
LA = Latex, SO = Solvent, DS = Direkt Sublimation, UV = UV Druck, TS = Transfer Sublimation



<b>seemee</b> <i>PVC frei</i>		<b>FRONTLIT – UV, SO, LA</b>			
Artikel	Bezeichnung	Gewicht (g/m <sup>2</sup> )	Breite (cm)	Länge (m)	Preis/m <sup>2</sup>
B 4073	Pure! Insight supreme	200	500/320 250/160	50	6,15
B 4144	Pure! Banner	230	500/320 250/160	50	4,40
<b>seemee</b> <i>flexface - PVC beschichtet</i>		<b>FRONTLIT – UV, SO, LA</b>			
Artikel	Bezeichnung	Gewicht (g/m <sup>2</sup> )	Breite (cm)	Länge (m)	Preis/m <sup>2</sup>
B 7613	seemee ultra matt Frontlit <b>B1</b>	480	500/320 250/160	50	2,45
B 7641	seemee standardFR Frontlit <b>B1/M2/BKZ</b>	550	500/320 250/160	50	3,65
B 7939	night & day Fronlit <b>B1/M2</b>	500	500/250	50	4,05
<b>seemee</b> <i>3P textil</i>		<b>DISPLAY - DS, LA</b>			
Artikel	Bezeichnung	Gewicht (g/m <sup>2</sup> )	Breite (cm)	Länge (m)	Preis/m <sup>2</sup>
B 4105	value display FR/ <b>B1</b>	225	320 250/160	50	2,85
B 4118	value stretch display FR/ <b>B1</b>	275	310 250/155	50	5,20
B 4142	premium display light FR	170	155/310	50	2,45
<b>seemee</b> <i>flexface – PVC beschichtet</i>		<b>MESH – UV, SO, LA</b>			
Artikel	Bezeichnung	Gewicht (g/m <sup>2</sup> )	Breite (cm)	Länge (m)	Preis/m <sup>2</sup>
B 3135	seemee solution Mesh <b>B1</b>	300	500/320	50	2,40
B 3131	seemee extra Mesh <b>B1/M1</b>	300	500/320	50	2,80
B 3127	seemee premium Mesh <b>B1/M1</b>	350	500/320	50	2,95

Teilung der Warenbreite: € 0,15/m<sup>2</sup> pro Schnitt – nur bei Abnahme der kompletten Originalbreite  
LA = Latex, SO = Solvent, DS = Direkt Sublimation, UV = UV Druck, TS = Transfer Sublimation







## WOOD EDITION

## rahmenlose Spanntechnik

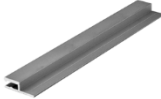
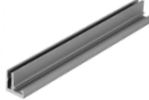
Artikel	Abbildung	Profilmaß Profillänge 3000mm	Anzahl/VE	Preis/lfm
7725-1 Buche 25		25x30mm	20	<b>14,70</b>
7726-1 Esche 25		25x30mm	20	<b>17,80</b>
7727-1 Eiche 25		25x30mm	20	<b>19,60</b>
7728-1 Wenge 25		25x30mm	20	<b>28,20</b>
7725-2 Buche 45LED		45x30mm	20	<b>19,40</b>
7726-2 Esche 45LED		45x30mm	20	<b>26,50</b>
7727-2 Eiche 45LED		45x30mm	20	<b>30,20</b>
7728-2 Wenge 45LED		45x30mm	20	<b>32,50</b>
7725-3 Buche DS		30x50mm	20	<b>24,10</b>
7726-3 Esche DS		30x50mm	20	<b>32,80</b>
7727-3 Eiche DS		30x50mm	20	<b>37,50</b>
7728-3 Wenge DS		30x50mm	20	<b>39,80</b>
7725-0 Eiche Querstrebe		16x16mm	20	<b>8,40</b>
7790-0 Steckverbinder		Alu Steckverbinder für Querstrebe 16mm	100	<b>2,10/Stk</b>
7791-0 Eckverbinder		Alu Eckverbinder	100	<b>2,40/Stk</b>
7792-0 Wandmontagewinkel		Alu Z-Winkel	100	<b>2,10/Stk</b>

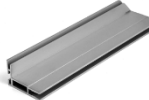
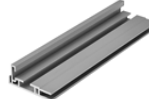
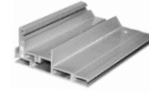
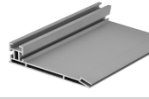
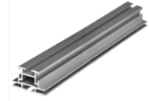
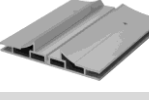
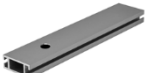
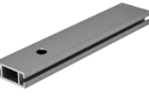



SlimFrame & SlimLight		rahmenlose Spanntechnik		
Artikel	Abbildung	Profilmaß Profillänge 6100mm	Anzahl/VE	Preis/lfm
T-SF Adapter		Ausführung 1-seitig Format 31 x 9mm	6	5,20
T-SF 17		Ausführung 1-seitig Gesamttiefe 17mm	6	6,60
T-SF 23		Ausführung 1-seitig Gesamttiefe 23mm	6	8,00
T-SL 45		Ausführung 1-seitig Gesamttiefe 45mm	6	8,50
T-SL 60		Ausführung 1-seitig Gesamttiefe 60mm	6	9,20
T-SL 85 FL		Ausführung 1-seitig Gesamttiefe 85mm	6	12,50
T-SL 120		Ausführung 1-seitig Gesamttiefe 120mm	6	19,90
<b>doppelseitige Ausführung</b>				
T-SF 55 DS		Ausführung 2-seitig Gesamttiefe 55mm	6	10,50
T-SL 120 DS		Ausführung 2-seitig Gesamttiefe 120mm	6	18,00
<b>Zubehör</b>				
T-SF Aussteifungsprofil A		Format: 40x16mm passend zu: SF23	6	9,10
T-SF Aussteifungsprofil B		Format: 45x19mm passend zu: SF55DS – SL120	6	9,10
T-SF Verbinderschloss A		passend zu: SF23	1	3,50/Stk
T-SF Verbinderschloss B		passend zu: SF55DS – SL120	1	3,50Stk

Profiloberfläche E6/EV1 eloxiert – Profillänge 6100mm



SlimFrame			Zubehör	
Artikel	Abbildung	Beschreibung	Anzahl/VE	Preis/Stk
T-SF Alu S		Eckverbinder Alu S passend zu: SF23	12	0,90
T-SF Alu M		Eckverbinder Alu M passend zu: SL120	12	0,90
T-SF Alu L		Eckverbinder Alu L passend zu: SL45 - SF55DS - SL60 - SL85FL - SL120 - SL120DS	12	1,70
T-SF Stahl S		Ecke Stahl S: passend zu SF 17	50	0,90
T-SF Stahl M2		Ecke Stahl M 2mm: passend zu SL 45	50	0,90
T-SF Stahl M3		Ecke Stahl M 3mm passend zu: SF23 - SF55DS - SL60 - SL85FL - SL120	50	1,10
T-SF gerader Verbinder		Verbinder 100mm passend zu: SF23 - SL45 - SF55DS - SL60 - SL85FL - SL120 - SL120DS	12	0,90
T-SF Füße Stahl		Edelstahl gebogen 500 x 50 x 5mm	1	28,90
T-SF Füße Alu S		Alu gerade 400 x 100 x 10mm	1	22,40
T-SF Füße Alu L		Alu gerade 600 x 100 x 10mm	1	26,80
T-SF Aufhängeset 55 DS		3m Länge passend zu: SF55DS	1	16,40
T-SF Schaniere 55 DS		passend zu: SF55DS	1	9,90



SlimFrame			Zubehör	
Artikel	Abbildung	Beschreibung	Anzahl/VE	Preis
T-FK 200		Flachkeder transparent 14 x 3mm	200 lfm	0,48/lfm
SF Versteifung rund		passend zu: SL85FL – SL120DS	1	6,90/lfm
Verbindungssockel		passend zu: SF Versteifung rund	1	9,90/Stk

**SlimFrame und SlimLight Zubehörteile**

Zubehör pro Profilkante	SF Adapter	SF 17	SF 23	SF 55 DS	SL 45	SL 60	SL 85 FL	SL 120	SL 120 DS
SF Versteifung/Schloss Profil A	-	-	x	-	-	-	-	-	-
SF Versteifung/Schloss Profil B	-	-	-	x	-	-	-	x	-
SF Versteifung rund/Socket	-	-	-	-	-	-	x	-	x
Fuß Edelstahl, gebogen	-	-	-	x	-	-	-	-	x
Fuß Alu, gerade 600mm	-	-	-	x	-	-	-	-	x
Fuß Alu, gerade 400mm	-	-	-	x	-	-	-	-	-
Eckverbinder Alu S	-	-	1	-	-	-	-	-	-
Eckverbinder Alu L	-	-	-	1	1	1	1	1	2
Eckverbinder Alu M	-	-	-	-	-	-	-	1	1
Eckverbinder Stahl S	-	1	-	-	-	-	-	-	-
Eckverbinder Stahl M2	-	-	-	-	1	-	-	-	-
Eckverbinder Stahl M3	-	-	1	2	-	1	1	2	2
gerader Verbinder Stahl	-	-	1	1	1	1	1	2	2

# Allgemeine Geschäftsbedingungen / General conditions of Sales

## 1. Allgemein / General:

1.1. Die Geschäftsbedingungen zwischen Lieferant und Besteller liegen die nachstehenden Allgemeinen Geschäftsbedingungen zu Grunde, sofern nicht andere Vereinbarungen schriftlich bestätigt werden.

*The terms of business conditions between supplier and ordered is based on the following general conditions of sale, if different agreements are not acknowledged in writing.*

1.2. Die allgemeinen Geschäftsbedingungen gelten auch für alle zukünftigen Aufträge des Bestellers, und zwar auch dann, wenn der Lieferant hierauf nicht in jedem einzelnen Fall Bezug nimmt.

*The general trading conditions are valid also for all future jobs of the ordered, even if the supplier does not take reference in each individual case.*

## 2. Angebot / Quotations:

2.1. Die Angebote der Lieferanten einschließlich der Lieferzeitgabe sind freibleibend.

*The quotations of the supplier including the delivery time specification are subject to alteration.*

2.2. Soweit nichts anderes vereinbart gelten die Preise ab Werk ohne Verpackungskosten.

*So far nothing different is agreed the prices are ex works excluding packing,*

2.3. Die Preise können ohne vorherige Ankündigung geändert werden.

*Prices are subject to change without notice.*

## 3. Bestellung und Auftragsbestätigung / Order and Order Confirmation:

3.1. Die Bestellung wird durch die Auftragsbestätigung des Lieferanten verbindlich. Etwaige Beanstandungen sind vom Besteller unverzüglich bekannt zu geben. Mündliche Nebenabreden sind nur gültig, wenn Sie vom Lieferanten schriftlich bestätigt werden.

*The order becomes obligatory by the order confirmation of the supplier. Any complains are to be announced by the order immediately.*

*Verbal special agreements are only valid if they are acknowledged in writing by the supplier*

## 4. Lieferung / Delivery:

4.1. Versand und Transport erfolgen auf Rechnung und Gefahr des Bestellers.

Etwaige Transportschäden müssen unverzüglich gegenüber dem Transporteur festgestellt werden.

*The merchandise will be sent on account and risk of the consignee. Any transport damages must be determined immediately opposite the forwarder.*

4.2. Der Lieferant ist für Lieferverzögerungen, Transportschwierigkeiten, Streiks oder anderen Umständen der Lieferverzögerung, auf die er keinen Einfluss hat nicht verantwortlich.

*The suppliers is not responsible for delays in, delivery, transportation difficulties, strikes or other circumstances which are quite beyond his control.*

4.3. Eine vertraglich vereinbarte Lieferfrist ist eingehalten, wenn die Ware einen Tag vor Fristablauf versandfrei ist und dies dem Kunden mitgeteilt hat.

*An agreed delivery time is kept, if the merchandise is ready for dispatch one day before expiration and indicated this to the customer.*

4.4. Wir können die meisten Artikel aus Vorrat liefern.

*We can deliver most items from stock.*

## 5. Preise und Bedingungen / Prices and Terms:

5.1. Unsere Preise verstehen sich ab Werk ohne Verpackungskosten.

*Prices are ex works and excluding packing.*

5.2. Die genannten Preise schließen jedoch keine Ladegebühren, Zoll, Steuern oder andere beim Eintritt in das Bestellerland entstehenden Kosten ein.

*The prices do not include any landing charges, duties, taxes or any other expense that may be involved in entry into the country of destination.*

5.3. Sofern nichts anderes angegeben gelten alle Preise für unbehandelte Aluminium-Profile.

*As far nothing different is indicated prices are for mill-finished aluminium-profiles.*

5.4. Alle Preise für Spanntücher sind per Quadratmeter angegeben und werden nur als komplette Rollen verkauft.

*All prices for flexible materials are per quadrate metres and is supplied in complete rolls only.*

5.5. Nehmen Sie bitte davon Kenntnis, dass die Tuchhalter in Verpackungseinheiten von 100, 250, 500 und 1000 Stück geliefert werden.

*Please note that the flex holders are supplied in either 100, 250, 500 or 1000 pieces packaging.*

## 6. Zahlungsbedingungen / Terms of Payment:

6.1. Sofern nichts anderes vereinbart ist, sind unsere Zahlungsbedingungen, netto bei Erhalt der Rechnung. Bei Lieferungen ins Ausland erfolgt sofort nach Eingang der Überweisung bzw. einer Bestätigung Ihrer Bank dass die Zahlung angewiesen wurde. Dies ist unsere übliche Geschäftspolitik bei Auslandsaufträgen.

*So far nothing different is agreed, our terms of payment are net with receipt of the invoice. On receipt of your remittance or acknowledgement of your bank that payment was instructed, your order will be despatched immediately. This is our usual policy when dealing with export orders.*

6.2. Bei Zahlungsverzug werden Verzugszinsen berechnet, ferner sind sämtliche Mahn- und Inkassokosten zu ersetzen.

*In case of default of payment interests are calculated, furthermore all reminding costs have to be replaced.*

## 7. Eigentumsvorbehalt / Proprietary rights:

7.1. Alle Waren des Lieferanten bleiben bis zur vollständigen Zahlung sämtlicher Forderungen Eigentum des Lieferanten.

*All goods remain in the property of the supplier up to the complete payment of all demands.*

## 8. Mängelrüge und Haftung / Responsibility for defects:

8.1. Mängel an der Ware sind dem Lieferanten unverzüglich anzuzeigen und zwar spätestens innerhalb von einer Woche nach Eingang der Ware am Bestimmungsort.

*Claims will be considered only if raised within a week after receipt of the goods at place of destination.*

8.2. Bei berechtigter Mängelrüge ist der Lieferant zur Nachbesserung und/oder Nachlieferung berechtigt.

*With justified point of criticism the supplier is entitled for the rework and/or subsequent delivery.*

Weitere Ansprüche sind ausgeschlossen, dies gilt insbesondere für Ansprüche auf Ersatz von Schäden die nicht an der Ware selbst entstanden sind (Mangelfolgeschäden).

*Further requirements are impossible, this apply in particular for damages incurred, which are not resulted at the goods (lack damages).*

8.3. Es gelten die gesetzlichen Verjährungsfristen.

*The legal periods of limitation are permitted.*

## 9. Erfüllungsort und Gerichtsstand / Place of Delivery and Performance:

9.1. Erfüllungsort und Gerichtsstand ist, soweit das Gesetz zwingend nichts anderes vorsieht der Sitz des Lieferanten.

*Place of delivery and area of jurisdiction mandatory is the seat of the supplier, so far the law intend nothing different. 11/01*