



PROFILSYSTEME FASSADENSYSTEME

Präsentationssysteme

Display

Pylonen

FRAMELESS-HOLZ

FRAMELESS

Frameless-Outlip/Outled

TEXTIL - PLANENWARE

LED Systeme

Verkehrsspiegel

Wechselrahmen

Schildersysteme

Stadtmöblierungen

Schaukästen – Vitrinen

pro4sign & tex4sign

LIEFERPROGRAMM / MMXVIII-III

HP&V-Partner

Ing. Peter Melenka

Rettenbachstrasse 162

5730 Mittersill

T: +43 6562 8573

F: +43 6562 8573 34

www.hpv-partner.com

office@hpv-partner.com



Inhalt

pro4sign	EPS.LUMI - Profile	Seite 3
pro4sign	EPS.LUMI - Werkzeug	Seite 4
pro4sign	EPS.LUMI - Elemente	Seite 4
pro4sign	EPS.REDY - Profile	Seite 6
pro4sign	EPS.REDY - Komponenten	Seite 7
pro4sign	EPS.EASY - Profile	Seite 8
pro4sign	EPS.EASY - Befestigungen	Seite 9
tex4sign	TEXTIL - Planenware	Seite 10
pro4sign	wood edition - rahmenlose Spanntechnik	Seite 11
pro4sign	SlimFrame & SlimLight rahmenlose Spanntechnik	Seite 12
pro4sign	SlimFrame – Zubehör	Seite 13
pro4sign	SlimFrame - Zubehörliste	Seite 14
	allg. Geschäftsbedingungen	Seite 15

Zahlungs- und Lieferbedingungen

Frachtkostenpauschalangebot ab Lager / Lagermax – 5020 Salzburg (innerhalb Österreich):

44,50 Frachtkosten für Profillängen bis 3,5m

89,00 Frachtkosten für Profillängen ab 3,6m

195,00 Frachtkostenpauschale für 1-3 Standardrollen bis 3,2m

240,00 Frachtkostenpauschale für 1-3 Standardrollen ab 3,3m

Zwischenverkauf vorbehalten

Preise exkl. 1,95% Verpackungs- und Handlingskosten vom Warenwert

Lieferart: ab Werk, zzgl. Mwst. - Staplerentladung kundenseits

Selbstabholung: nur gegen Rücksprache

Irrtümer vorbehalten

*** nicht lagernde Ware – Frachtkosten auf Anfrage**

Firmensitz

Zentrale:

HP&V-Partner

Ing. Peter Melenka

5730 Mittersill, Rettenbachstrasse 162

T: +43 6562 8573

F: +43 6562 8573 34

M: office@hvp-partner.com

W: www.hvp-partner.com









Lager:

Fa. Lagermax



Radingerstrasse 16

5020 Salzburg



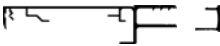
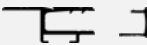
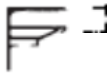

















EPS. LUMI			Profile
Artikel	Abbildung	Profilmaß	Anzahl/VE
EPS 1-001 Grundprofil breit		240x6000mm	6
EPS 1-004 Grundprofil schmal		170x6000mm	6
EPS 1-009 * Grundprofil doppelseitig		260x6000mm	-
EPS 1-011 * Aufsatzprofil 83 JR		83x6000mm	-
EPS 1-015 Aufsatzprofil JR leicht		85x6000mm	6
EPS 1-016 Aufsatzprofil SR schwer		112x6000mm	6
EPS 1-022 Abdeckprofil JR leicht		57x6000mm	6
EPS 1-023 Abdeckprofil SR schwer		63x6000mm	6
EPS 1-021 * Abdeckprofil JR Wassernase		60x6000mm	-

EPS. LUMI GRIP			Profile
Artikel	Abbildung	Profilmaß	Anzahl/VE
EPS 1-101 Grund- inkl. Abdeckprofil		176x6000mm	6
EPS 1-111 Aufsatz- inkl. Abdeckprofil		67x6000mm	6
EPS 1-121 Wand- inkl. Abdeckprofil		50x6000mm	6



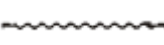

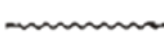



EPS. LUMI GRIP			Elemente
Artikel	Abbildung	Profilmaß	Anzahl/VE
EPS 1-086 Verbindungsplatte		92x150mm für EPS 1-101	1
EPS 1-087 Eckverbinder		50x50x92mm für EPS 1-101	1

* kein Lagerartikel – auf Anfrage















EPS. LUMI			Werkzeuge
Artikel	Abbildung	Anzahl/VE	
EPS 1-058 Druckluft-Meisel		1	
EPS 1-060 Gummihammer		1	
EPS 1-062 Tuchhalter-Spanner		1	
EPS 1-063 Profillöser		1	
EPS 1-064 Tuchhalter-Hebel		1	
EPS 1-065 Tuchhalter-Zange		1	
EPS. LUMI			Elemente
Artikel	Abbildung	Profilmmaß	Anzahl/VE
EPS 1-028 Eckwinkel		66x43x6000mm	4
EPS 1-029 Außenecken-Abdeckung		36x6000mm	4
EPS 1-030 Stoß-Abdeckung		36x6000mm	4
EPS 1-031 Innenecken-Abdeckung		36x6000mm	4
EPS 1-072 Tuchhalter		50mm	500
EPS 1-074 Tuchhalter		50mm	250
EPS 1-077 Tuchhalter		50mm	100
EPS 1-097 Tuchhalter kurz		25mm	100
EPS 1-053 Aussteifungsprofil		für EPS 1-001, 1-004, 1-101	1
EPS 1-042 Verbindungsplatte		für EPS 1-001	1
EPS 1-046 Eckverbinder		für EPS 1-001	1
EPS 1-080 Verbindungsplatte		für EPS 1-004	1
EPS 1-081 Eckverbinder		für EPS 1-004	1

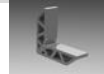
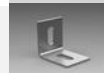

EPS. REDY			Profile
Artikel	Abbildung	Profilmaß	Anzahl/VE
EPS 6-002 Profil C		20x9x3500mm	12
EPS 6-007 Profil KTA+		27x9x3500mm	12
EPS 6-008 Profil KL+		49x20x3500mm	12
EPS 6-055 Profil KTN+		37x22x3500mm	12
EPS 6-045 Profil KT+		64x37x3500mm 64x37x6000mm	4
EPS 6-047 Profil KT4		37x37x3500mm 37x37x6000mm	4
EPS 6-057 Profil KT8		86x86x4000mm 86x86x6000mm	4
EPS 6-037 Profil KPPS		161x22x3500mm	4
EPS 6-051 Abdeckwinkel L20		Alu natur, 25x25x3000mm	5

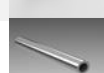

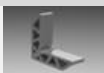
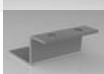
EPS. REDY		Klemmleisten (UV-stabilisiert)	
Artikel	Abbildung	Profilmaß	Anzahl/VE
EPS 6-120 (6-100) Klemmleiste CN weiß		3500mm In- & Outdoor	12
EPS 6-125 (6-110) Klemmleiste CS weiß		3500mm – verstärkt In- & Outdoor	12
EPS 6-121 (6-108) Klemmleiste CN silber		3500mm In- & Outdoor	12
EPS 6-126 (6-112) Klemmleiste CS silber		3500mm – verstärkt In- & Outdoor	12
EPS 6-122 (6-109) Klemmleiste CN schwarz		3500mm In- & Outdoor	12
EPS 6-127 (6-111) Klemmleiste CS schwarz		3500mm – verstärkt In- & Outdoor	12



EPS. REDY		Komponenten - KT8	
Artikel	Abbildung	Bezeichnung	Anzahl/VE
EPS 6-280 Eckverbinder		EQ KT8L Eckverbinder 90°	1
EPS 6-282 Eckverstärkung		EQ KT8A Eckwinkel 81x81mm	1
EPS 6-284 verstellbare Eckverstärkung		EQ KT8F Eckwinkel 40-180°	1
EPS 6-286 Verbindungsplatte		PL KT8 Verbindungsplatte	1
EPS 6-288 Kopfplatte		DE KT8 Kopfplatte	1
EPS 6-271 Nutenstein		CLM M6 T-Nutenstein	35
EPS. REDY		Komponenten - KT4, KT+	
Artikel	Abbildung	Bezeichnung	Anzahl/VE
EPS 6-214 Eckverbinder		EQ ABS Eckverbinder	50
EPS 6-228 Eckverstärkung 90°		EQ KT+ Eckverstärkung 90°	10
EPS 6-220 Eck- Wandbefestigung		EQ KT+ MUR Eck- Wandbefestigung	10
EPS 6-226 verstellb. Eckverstärkung		EQ ART KT+ 0-180°	10
EPS 6-156 Verbindungsrohr		Aluverbindungsrohr 100mm	10
EPS 6-271 Nutenstein		CLM M6 T-Nutenstein	35
EPS. REDY		Komponenten - C, KTA+, KL+, KTN+	
Artikel	Abbildung	Bezeichnung	Anzahl/VE
EPS 6-214 Eckverbinder		EQ ABS Eckverbinder	50
EPS 6-241 Befestigungswinkel		PFIX für Rahmenaufhängung	10
EPS 6-156 Verbindungsrohr		Aluverbindungsrohr 100mm	10
EPS. REDY		Werkzeug	
EPS 6-300 Gehrungsschere		-	1







EPS. EASY			Profile
Artikel	Abbildung	Profilmaß	Anzahl/VE
EPS 7-001 Kederprofil oval eloxiert		16x40 x 6000mm	6
EPS 7-001-300 Kederprofil oval eloxiert		16x40 x 3000mm	6
EPS 7-002 Kederprofil oval natur		16x40 x 6000mm	6
EPS 7-002-300 Kederprofil oval natur		16x40 x 3000mm	6
EPS 7-005 Kederprofil rund eloxiert		30 x 6000mm	6
EPS 7-005-300 Kederprofil rund eloxiert		30 x 3000mm	6
EPS 7-006 Kederprofil rund natur		30 x 6000mm	6
EPS 7-006-300 Kederprofil rund natur		30 x 3000mm	6
EPS 7-010 Alu-Rundrohrkeder		8 x 6000mm	6

EPS. EASY			Kunststoff - Endstopfen
Artikel	Abbildung	Profilmaß	Anzahl/VE
EPS 7-050 Endstopfen oval		16x40mm	4
EPS 7-052 Endstopfen rund		D=30mm	4

EPS. EASY			Verbinder
Artikel	Abbildung	Beschreibung	Anzahl/VE
EPS 7-060 Profilverbinder verzinkt		starr	1
EPS 7-062 Gelenkverbinder verzinkt		vertikal	1
EPS 7-064 Gelenkverbinder verzinkt		horizontal	1



EPS. EASY		Befestigungen	
Artikel	Abbildung	Profilmaß	Anzahl/VE
EPS 7-080 EASYQUICK - Wandhalter		96x50mm	1
EPS 7-086 Einfach - Wandhalter		40mm	2
EPS 7-088 Boden- / Deckenhalter		40mm	2
EPS 7-090 Wandflansch		59x50mm	1
EPS 7-092 Drahtseilspanner		40x15mm	2
EPS 7-094 Ösenschraube		M5	2
EPS 7-096 Alu Nutenstein		8mm	2
EPS 7-098 Boden- / Deckenspanner		35x16mm	2
EPS 7-100 Boden- / Deckenspanner mit 3-Loch Fußplatte		35x40mm	2
EPS 7-102 Boden- / Deckenhaken		4,4x83mm	2
EPS 7-104 Drahtseilspanner/Öse		38x17mm mit Öse	2
EPS 7-106 Drahtseilspanner/Haken		38x15mm mit Haken	2
EPS 7-108 Drahtseilspanner/Gew.		0,55kg mit Gewicht	1
EPS 7-110 Spannschloss		35mm Spannweg mit beidseitiger Ösen	2
EPS 7-120 Edelstahl - Drahtseil		1,5mmx25m	1
EPS 7-128 Edelstahl - Drahtseil		1,5mmx10m	1
EPS 7-134 Alupressklemmen		-	50



TEXTIL		BACKLIT – Durchlicht		
Artikel	Bezeichnung	Gewicht (g/m ²)	Breite (cm)**	Länge (m)

B 1150	seemee II Backlit B1 5 Jahre Garantie*	550	320/160	50
B 3852	seemee IV Backlit B1/M2/UL 7 Jahre Garantie*	550	500 /380 250	50

B 1149	seemee IV Backlit B1/M2/UL 7 Jahre Garantie*	650	320/160	50
--------	---	-----	---------	----

Die oben angeführten Materialien sind für Druck und **selbstklebende namhafte Folien** geeignet.
* Jahresqualität lt. Herstellerangabe

B 7970	seemee supreme Backlit B1/M1	450	500 /320 250/160	50
--------	--	-----	----------------------------	----

B 7955/56	seemee LED Backlit B1 > 40% Transluzenz	330	500 /320 250/160	50
-----------	--	-----	----------------------------	----

TEXTIL		FRONTLIT – Solvent, UV & Latex		
Artikel	Bezeichnung	Gewicht (g/m ²)	Breite (cm)	Länge (m)

B 7978	seemee extra plus Frontlit B1	510	500 /320 250/160	50
--------	---	-----	----------------------------	----

B 7641	seemee standardFR Frontlit B1/M2/BKZ	550	500 /320 250/160	50
--------	--	-----	----------------------------	----

TEXTIL		MESH – Solvent & UV		
Artikel	Bezeichnung	Gewicht (g/m ²)	Breite (cm)	Länge (m)

B 3135	seemee solution Mesh B1	300	500 /320	50
--------	-----------------------------------	-----	-----------------	----

B 3131	seemee extra Mesh B1/M1	300	500 /320	50
--------	-----------------------------------	-----	-----------------	----

B 3127	seemee premium Mesh B1/M1	350	500 /320	50
--------	-------------------------------------	-----	-----------------	----













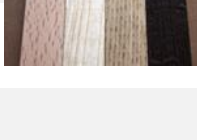

B 3704	seemee fassade Mesh B1	480	300	50
--------	----------------------------------	-----	-----	----

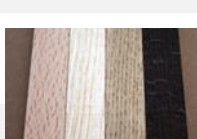
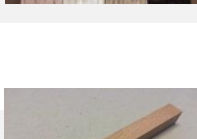
** Sonderbreiten auf Anfrage
Teilung der Warenbreite: € 0,15/m² pro Schnitt – nur bei Abnahme der kompletten Originalbreite







WOOD EDITION

rahmenlose Spanntechnik

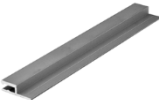
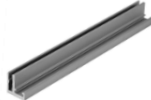

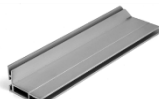
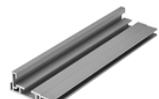
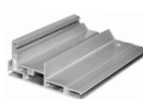
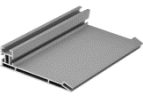
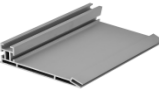
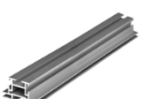
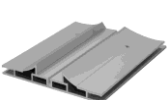
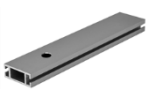
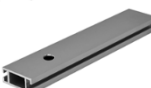









Artikel	Abbildung	Profilmaß Profillänge 3000mm	Anzahl/VE
7725-1 Buche 25		25x30mm	20
7726-1 Esche 25		25x30mm	20
7727-1 Eiche 25		25x30mm	20
7728-1 Wenge 25		25x30mm	20
7725-2 Buche 45LED		45x30mm	20
7726-2 Esche 45LED		45x30mm	20
7727-2 Eiche 45LED		45x30mm	20
7728-2 Wenge 45LED		45x30mm	20
7725-3 Buche DS		30x50mm	20
7726-3 Esche DS		30x50mm	20
7727-3 Eiche DS		30x50mm	20
7728-3 Wenge DS		30x50mm	20
7725-0 Eiche Querstrebe		16x16mm	20
7790-0 Steckverbinder		Alu Steckverbinder für Querstrebe 16mm	100
7791-0 Eckverbinder		Alu Eckverbinder	100
7792-0 Wandmontagewinkel		Alu Z-Winkel	100



SlimFrame & SlimLight		rahmenlose Spanntechnik	
Artikel	Abbildung	Profilmaß Profillänge 6100mm	Anzahl/VE
T-SF Adapter		Indoor Ausführung 1-seitig Format 31 x 9mm	6
T-SF 17		Indoor Ausführung 1-seitig Gesamttiefe 17mm	6
T-SF 23		Indoor Ausführung 1-seitig Gesamttiefe 23mm	6
T-SL 45		Indoor Ausführung 1-seitig Gesamttiefe 45mm	6
T-SL 60		Indoor Ausführung 1-seitig Gesamttiefe 60mm	6
T-SL 85 FL		Indoor Ausführung 1-seitig Gesamttiefe 85mm	6
T-SL 80		Outdoor/Indoor Ausführung 1-seitig Gesamttiefe 80mm	6
T-SL 120		Outdoor/Indoor Ausführung 1-seitig Gesamttiefe 120mm	6
doppelseitige Ausführung			
T-SF 55 DS		Indoor Ausführung 2-seitig Gesamttiefe 55mm	6
T-SL 120 DS		Indoor Ausführung 2-seitig Gesamttiefe 120mm	6
Zubehör			
T-SF Aussteifungsprofil A		Format: 40x16mm passend zu: SF23	6
T-SF Aussteifungsprofil B		Format: 45x19mm passend zu: SF55DS – SL120	6
T-SF Verbinderschloss A		passend zu: SF23	1
T-SF Verbinderschloss B		passend zu: SF55DS – SL120	1

Profiloberfläche E6/EV1 eloxiert – Profillänge 6100mm



SlimFrame			Zubehör
Artikel	Abbildung	Beschreibung	Anzahl/VE
T-SF Alu S		Eckverbinder Alu S passend zu: SF23	12
T-SF Alu M		Eckverbinder Alu M passend zu: SL120	12
T-SF Alu L		Eckverbinder Alu L passend zu: SL45 - SF55DS - SL60 - SL80 SL85FL - SL120 - SL120DS	12
T-SF Alu XL		Eckverbinder Alu XL passend zu: SL80	12
<hr/>			
T-SF Stahl S		Ecke Stahl S: passend zu SF 17	50
T-SF Stahl M2		Ecke Stahl M 2mm: passend zu SL 45	50
T-SF Stahl M3		Ecke Stahl M 3mm passend zu: SF23 - SF55DS - SL60 - SL80 SL85FL - SL120	50
T-SF gerader Verbinder		Verbinder 100mm passend zu: SF23 - SL45 SF55DS - SL60 - SL80 SL85FL - SL120 - SL120DS	12
<hr/>			
T-SF Füße Stahl		Edelstahl gebogen 500 x 50 x 5mm	1
T-SF Füße Alu S		Alu gerade 400 x 100 x 10mm	1
T-SF Füße Alu L		Alu gerade 600 x 100 x 10mm	1
<hr/>			
T-SF Aufhangeset 55 DS		3m Länge passend zu: SF55DS	1
T-SF Schaniere 55 DS		passend zu: SF55DS	1



SlimFrame			Zubehör
Artikel	Abbildung	Beschreibung	Anzahl/VE
SF Versteifung rund		passend zu: SL85FL – SL120DS	1
Verbindungssockel		passend zu: SF Versteifung rund	1

SlimFrame und SlimLight Zubehörteile

Zubehör pro Profilkante	SF Adapter	SF 17	SF 23	SF 55 DS	SL 45	SL 60	SL 80	SL 85 FL	SL 120	SL 120 DS
SF Versteifung/Schloss Profil A	-	-	x	-	-	-	-	-	-	-
SF Versteifung/Schloss Profil B	-	-	-	x	-	-	x	-	x	-
SF Versteifung rund/Socket	-	-	-	-	-	-	-	x	-	x
Fuß Edelstahl, gebogen	-	-	-	x	-	-	-	-	-	x
Fuß Alu, gerade 600mm	-	-	-	x	-	-	-	-	-	x
Fuß Alu, gerade 400mm	-	-	-	x	-	-	-	-	-	-
Eckverbinder Alu S	-	-	1	-	-	-	-	-	-	-
Eckverbinder Alu L	-	-	-	1	1	1	1	1	1	2
Eckverbinder Alu M	-	-	-	-	-	-	-	-	1	-
Eckverbinder Alu XL	-	-	-	-	-	-	1	-	-	-
Eckverbinder Stahl S	-	1	-	-	-	-	-	-	-	-
Eckverbinder Stahl M2	-	-	-	-	1	-	-	-	-	-
Eckverbinder Stahl M3	-	-	1	2	-	1	1	1	2	-
gerader Verbinder Stahl	-	-	1	1	1	1	1	-	2	2

Allgemeine Geschäftsbedingungen / General conditions of Sales

1. Allgemein / General:

1.1. Die Geschäftsbedingungen zwischen Lieferant und Besteller liegen die nachstehenden Allgemeinen Geschäftsbedingungen zu Grunde, sofern nicht andere Vereinbarungen schriftlich bestätigt werden.

The terms of business conditions between supplier and ordered is based on the following general conditions of sale, if different agreements are not acknowledged in writing.

1.2. Die allgemeinen Geschäftsbedingungen gelten auch für alle zukünftigen Aufträge des Bestellers, und zwar auch dann, wenn der Lieferant hierauf nicht in jedem einzelnen Fall Bezug nimmt.

The general trading conditions are valid also for all future jobs of the ordered, even if the supplier does not take reference in each individual case.

2. Angebot / Quotations:

2.1. Die Angebote der Lieferanten einschließlich der Lieferzeitgabe sind freibleibend.

The quotations of the supplier including the delivery time specification are subject to alteration.

2.2. Soweit nichts anderes vereinbart gelten die Preise ab Werk ohne Verpackungskosten.

So far nothing different is agreed the prices are ex works excluding packing,

2.3. Die Preise können ohne vorherige Ankündigung geändert werden.

Prices are subject to change without notice.

3. Bestellung und Auftragsbestätigung / Order and Order Confirmation:

3.1. Die Bestellung wird durch die Auftragsbestätigung des Lieferanten verbindlich. Etwaige Beanstandungen sind vom Besteller unverzüglich bekannt zu geben. Mündliche Nebenabreden sind nur gültig, wenn Sie vom Lieferanten schriftlich bestätigt werden.

The order becomes obligatory by the order confirmation of the supplier. Any complains are to be announced by the order immediately.

Verbal special agreements are only valid if they are acknowledged in writing by the supplier

4. Lieferung / Delivery:

4.1. Versand und Transport erfolgen auf Rechnung und Gefahr des Bestellers.

Etwaige Transportschäden müssen unverzüglich gegenüber dem Transporteur festgestellt werden.

The merchandise will be sent on account and risk of the consignee. Any transport damages must be determined immediately opposite the forwarder.

4.2. Der Lieferant ist für Lieferverzögerungen, Transportschwierigkeiten, Streiks oder anderen Umständen der Lieferverzögerung, auf die er keinen Einfluss hat nicht verantwortlich.

The suppliers is not responsible for delays in, delivery, transportation difficulties, strikes or other circumstances which are quite beyond his control.

4.3. Eine vertraglich vereinbarte Lieferfrist ist eingehalten, wenn die Ware einen Tag vor Fristablauf versandfrei ist und dies dem Kunden mitgeteilt hat.

An agreed delivery time is kept, if the merchandise is ready for dispatch one day before expiration and indicated this to the customer.

4.4. Wir können die meisten Artikel aus Vorrat liefern.

We can deliver most items from stock.

5. Preise und Bedingungen / Prices and Terms:

5.1. Unsere Preise verstehen sich ab Werk ohne Verpackungskosten.

Prices are ex works and excluding packing.

5.2. Die genannten Preise schließen jedoch keine Ladegebühren, Zoll, Steuern oder andere beim Eintritt in das Bestellerland entstehenden Kosten ein.

The prices do not include any landing charges, duties, taxes or any other expense that may be involved in entry into the country of destination.

5.3. Sofern nichts anderes angegeben gelten alle Preise für unbehandelte Aluminium-Profile.

As far nothing different is indicated prices are for mill-finished aluminium-profiles.

5.4. Alle Preise für Spanntücher sind per Quadratmeter angegeben und werden nur als komplette Rollen verkauft.

All prices for flexible materials are per quadrate metres and is supplied in complete rolls only.

5.5. Nehmen Sie bitte davon Kenntnis, dass die Tuchhalter in Verpackungseinheiten von 100, 250, 500 und 1000 Stück geliefert werden.

Please note that the flex holders are supplied in either 100, 250, 500 or 1000 pieces packaging.

6. Zahlungsbedingungen / Terms of Payment:

6.1. Sofern nichts anderes vereinbart ist, sind unsere Zahlungsbedingungen, netto bei Erhalt der Rechnung. Bei Lieferungen ins Ausland erfolgt sofort nach Eingang der Überweisung bzw. einer Bestätigung Ihrer Bank dass die Zahlung angewiesen wurde. Dies ist unsere übliche Geschäftspolitik bei Auslandsaufträgen.

So far nothing different is agreed, our terms of payment are net with receipt of the invoice. On receipt of your remittance or acknowledgement of your bank that payment was instructed, your order will be despatched immediately. This is our usual policy when dealing with export orders.

6.2. Bei Zahlungsverzug werden Verzugszinsen berechnet, ferner sind sämtliche Mahn- und Inkassokosten zu ersetzen.

In case of default of payment interests are calculated, furthermore all reminding costs have to be replaced.

7. Eigentumsvorbehalt / Proprietary rights:

7.1. Alle Waren des Lieferanten bleiben bis zur vollständigen Zahlung sämtlicher Forderungen Eigentum des Lieferanten.

All goods remain in the property of the supplier up to the complete payment of all demands.

8. Mängelrüge und Haftung / Responsibility for defects:

8.1. Mängel an der Ware sind dem Lieferanten unverzüglich anzuzeigen und zwar spätestens innerhalb von einer Woche nach Eingang der Ware am Bestimmungsort.

Claims will be considered only if raised within a week after receipt of the goods at place of destination.

8.2. Bei berechtigter Mängelrüge ist der Lieferant zur Nachbesserung und/oder Nachlieferung berechtigt.

With justified point of criticism the supplier is entitled for the rework and/or subsequent delivery.

Weitere Ansprüche sind ausgeschlossen, dies gilt insbesondere für Ansprüche auf Ersatz von Schäden die nicht an der Ware selbst entstanden sind (Mangelfolgeschäden).

Further requirements are impossible, this apply in particular for damages incurred, which are not resulted at the goods (lack damages).

8.3. Es gelten die gesetzlichen Verjährungsfristen.

The legal periods of limitation are permitted.

9. Erfüllungsort und Gerichtsstand / Place of Delivery and Performance:

9.1. Erfüllungsort und Gerichtsstand ist, soweit das Gesetz zwingend nichts anderes vorsieht der Sitz des Lieferanten.

Place of delivery and area of jurisdiction mandatory is the seat of the supplier, so far the law intend nothing different. 11/01